

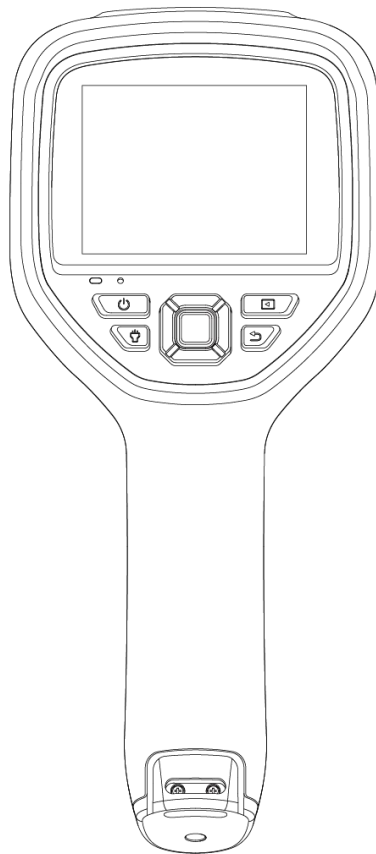

THOR Series

Handheld Thermal Camera

User Manual V1.1.0



Thermal Master Technology Co.,Ltd.

Table of Contents

1 Safety Information	1
2 Camera Overview	3
2.1 Front View	3
2.2 Rear View	4
2.3 Connector & Memory Card	5
3 Quick Start Guide	6
4 Screen Elements	7
5 Operation	9
5.1 Power On & Off	9
5.2 Save Images	9
5.3 View/Delete Images	9
5.4 Center Spot Temperature Measurement	9
5.5 Cold/Hot Spot Tracking	10
5.6 Custom Spot Measurement	10
5.7 Image Settings	10
5.7.1 Image Modes	10
5.7.2 Steps to Change Image Mode	11
5.7.3 Color Palette Settings	11
5.8 Shutter Calibration	11
5.8.1 Introduction to Shutter Calibration	11
5.8.2 Shutter Calibration Operation	12
5.9 Digital Zoom	12
5.10 Fusion Ratio	12
5.11 Temperature Difference Analysis	12
5.12 Dual-spectrum Alignment	12
6 Settings	13
6.1 Measurement Parameters	13
6.1.1 Emissivity Settings	13
6.1.2 Ambient Temperature Settings	14
6.1.3 Distance Settings	14
6.2 Temperature Measurement Range	14
6.3 Temperature Scale Mode	14
6.4 Alarm Settings	14
6.5 Photo Settings	15
6.5.1 Auto Image Saving	15

6.5.2 Time-lapse Image Capture	15
6.6 Isotherm	15
6.7 Real-Time Super-Resolution	15
6.8 Video Capture Settings	15
6.9 Index Mode	15
6.10 Macro Lens (Note: This feature is not available on THOR002)	15
6.11 Unit Settings	16
6.12 Wi-Fi Settings	16
6.13 On-screen Display	16
6.14 Auto Power Off	16
6.15 System Settings	16
7 Technical Data	17
8 Application Scenario Introduction	21
8.1 Warehouse Inspection	21
8.2 Switchgear Cabinet Inspection	21
8.3 Automobile Rear Window Defroster Maintenance	21
8.4 HVAC Maintenance	21
9 Dimensions	22
10.Cleaning Thermal Camera	23
10.1 Cleaning Camera Housing, Cables and Other Items	23
10.2 Cleaning Infrared Lens	23
Appendix A Emissivity of Commonly Used Materials	24

1 Safety Information

 WARNING
<p>Make sure you read all applicable Material Safety Data Sheets (SDS) and warning labels on containers before you use a liquid. The liquids can be dangerous. Injury to persons can occur.</p>
<p>Do not place the product in high-temperature environments above 60°C or low-temperature environments below -20°C.</p>
<p>Do not disassemble or modify the infrared thermal camera without authorization.</p>
<p>This device complies with part 15 of the FCC Rules. Operation is subject to the following two conditions:</p> <ul style="list-style-type: none"> (1) This device may not cause harmful interference, (2) this device must accept any interference received, including interference that may cause undesired operation. <p>Any Changes or modifications not expressly approved by the party responsible for compliance could void the user's authority to operate the equipment.</p> <p>Note: This equipment has been tested and found to comply with the limits for a Class A digital device, pursuant to part 15 of the FCC Rules. These limits are designed to provide reasonable protection against harmful interference when the equipment is operated in a commercial environment. This equipment generates, uses, and can radiate radio frequency energy and, if not installed and used in accordance with the instruction manual, may cause harmful interference to radio communications. Operation of this equipment in a residential area is likely to cause harmful interference in which case the user will be required to correct the interference at his own expense.</p>

 CAUTION
<p>Do not use the product under conditions that doesn't match the environmental requirements. For specific use environment requirements, see the product parameter table.</p>
<p>Do not apply solvents or equivalent liquids to the camera, the cables, or other items.</p>
<p>Be careful when you clean the infrared lenses. The lens has an anti-reflective coating which is easily damaged. Damage to the infrared lens can occur with too much force or cleaning with rough objects such as tissues.</p>
<p>No matter there is a lens cover or not, do not point the infrared thermal camera towards strong light or equipment with laser radiation. This will affect the accuracy of</p>

the thermal camera and even damage the detector in the thermal camera.



(EU)2023/1542 (battery directive): This product contains a battery that cannot be disposed of as unsorted municipal waste in the European Union. See the product documentation for specific battery information. The battery is marked with this symbol, which may include lettering to indicate cadmium (Cd), lead (Pb), or mercury (Hg). For proper recycling, return the battery to your supplier or to a designated collection point. For more information see: www.recyclethis.info



2012/19/EU (WEEE directive): Products marked with this symbol cannot be disposed of as unsorted municipal waste in the European Union. For proper recycling, return this product to your local supplier upon the purchase of equivalent new equipment, or dispose of it at designated collection points. For more information see: www.recyclethis.info

2 Camera Overview

2.1 Front View

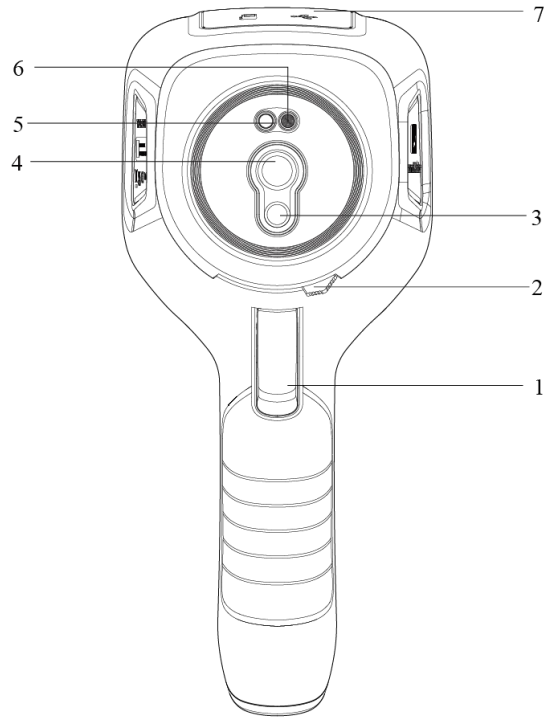

No.	Name	No.	Name
1	Image capture(short press)/video recording(long press)	2	Lever to open and close the lens cap
3	Digital camera lens	4	Infrared lens
5	Laser pointer	6	LED lamp
7	Cover for the USB connector and memory card slot		

Note: the laser warning label with the following information is attached to the camera.



2.2 Rear View

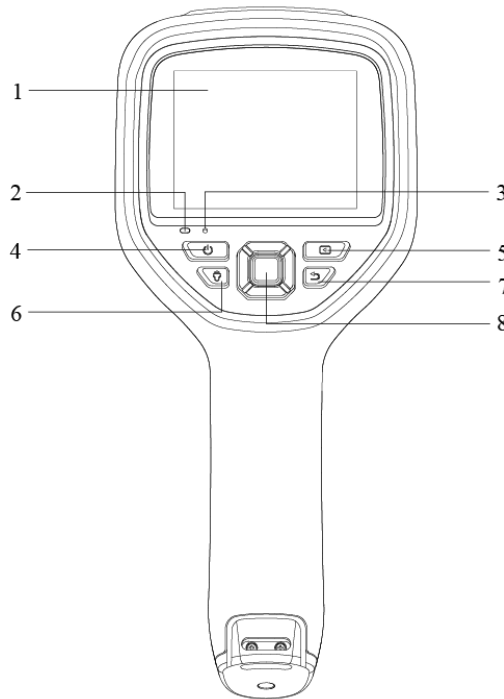

No.	Name	Function Description
1	Camera screen	Image and function display
2	Charging Indicator	Displays the charging status
3	Microphone	For voice annotation
4	Power button	<ul style="list-style-type: none"> ● Long press: Power on/off ● Short press: Sleep/wake
5	Gallery button	Single click to view the image archive
6	LED button	<ul style="list-style-type: none"> ● Short press: LED lamp ● Long press: Laser pointer
7	Back button	<ul style="list-style-type: none"> ● On the home screen: Image calibration ● Return/exit
8	Navigation pad	<ul style="list-style-type: none"> ● On the home screen: Press the center to bring up the main menu. ● On the home screen: Push left/right for digital zoom in infrared and visual image modes. Push left/right to adjust fusion ratio in fusion mode. ● In fusion mode: Use the left and right buttons to adjust the fusion ratio.

2.3 Connector & Memory Card



No.	Name	Description
1	USB connector	<ul style="list-style-type: none"> ● Use a USB cable to connect the power adapter for charging. ● Use a USB cable to connect to a computer for charging or data transfer.
2	SD card slot	<ul style="list-style-type: none"> ● Standard Micro SD card, user-expandable, supporting up to 128GB. ● The SD card can be removed and used with a card reader to transfer data to a PC or other devices.

3 Quick Start Guide

Please follow these steps:

1.Charging

- Use a 5V 1A or 5V 2A power adapter and USB cable to charge the camera.
- Alternatively, connect the camera to a computer using the included USB cable for charging.
- To charge, open the protective cover on the top of the camera, connect one end of the data cable to the USB TYPE-C port on the camera, and the other end to the adapter or computer.

2.Power On

Long press the power button  to turn on the camera.

3.Locate Target

Aim the thermal camera at the object of interest.



4.Capture Image

Press the trigger button once to capture an image.

5.PC Analysis

Download and launch the thermal camera client software. Import the data using a USB cable or SD card for secondary analysis.

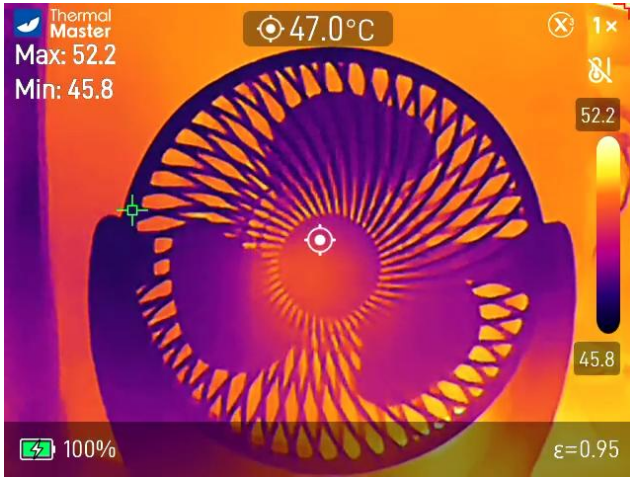
4 Screen Elements

Name	Description	Screen Presentation
Home Screen	Live view, Max, Min, Center spot, Wi-Fi hotspot, SD card, Digital zoom level, Temperature scale, Battery level, Date & time, Emissivity, etc.	
Main Menu	Measurement, Image mode, Color Palettes and Settings	
Measurement	Center spot, Cold/Hot spot, Custom spot(up to 6), Temperature difference analysis(See details in section 5.11)	

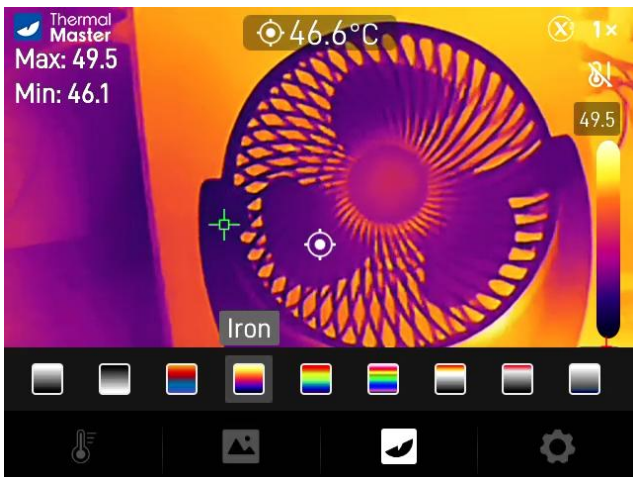
<p>Image Mode</p>	<p>IR, Visual, PIP, Fusion, Imix and Fusion alignment (See details in section 5.12)</p>	
<p>Color Palettes</p>	<p>7–9 types, differentiated by model</p>	
<p>Settings</p>	<p>See details in section 6</p>	

5 Operation

5.1 Power On & Off

1. In the power-off state, long press the power button to turn on the device.
2. In the power-on state, long press the power button to turn off the device.
3. If the device becomes unresponsive, long press the power button to force a shutdown.

5.2 Save Images

1. In auto save mode, press the trigger button to automatically save the image.
2. In manual save mode, press the trigger button and then manually choose to save, add voice annotations, scan QR code to rename, or cancel saving the image.
3. Select the Voice Annotation icon, press the Confirm button to start microphone recording. Press the Confirm button again to stop recording. You can add a voice annotation to the current image.
4. Select QR Code Filing, press the Confirm button to enter the QR code scanning interface. After scanning, the QR code content will automatically be used as the file name.

Note: The automatic/manual mode can be switched in the Settings – Capture settings.

5.3 View/Delete Images

Once you have captured and saved an image, it is stored on the SD card. You can follow these steps to view the saved image at any time:

1. Press the Gallery button to enter the image archive.
2. Use the direction buttons on the navigation pad to select the image you want to view.
3. Press the center on the navigation pad to view the image in full screen.
4. Press the back button repeatedly to return to the thermal imaging interface.

5.4 Center Spot Temperature Measurement



You can use spotmeter to measure the temperature, and the result will be displayed at the top left corner of the screen.

1. In the thermal imaging interface, press the confirm button to display the main menu toolbar.
2. In the toolbar, select the "Measurement" option  and press the confirm button to display the sub menu toolbar.

3. In the toolbar, select the "Center Spot" option  and press the confirm button to enable center spot temperature measurement (enabled by default). The temperature of the center spot will be displayed at the top of the screen.

5.5 Cold/Hot Spot Tracking

You can enable cold spot/hot spot tracking, which will display the position of the Min/Max temperature on the screen as a moving spot marker:

1. In the thermal imaging interface, press the confirm button to display the main menu toolbar.
2. In the toolbar, select the "Measurement" option  and press the confirm button to display the sub menu toolbar.
3. In the toolbar, select "Hot Spot"  or "Cold Spot"  and press the confirm button to enable the corresponding function.

5.6 Custom Spot Measurement

1. In the thermal imaging interface, press the confirm button to display the main menu toolbar.
2. In the toolbar, select the "Measurement" option  and press the confirm button to display the sub menu toolbar.
3. In the toolbar, select the "Custom Spot 1" option. Use the navigation buttons to move the custom spot to the desired location on the imaging interface. Press the confirm button to confirm the location, or press the back button to cancel the placement. Selecting "Custom Spot 1" again will disable the custom spot display function. The same procedure applies to "Custom Spot 2" and "Custom Spot 3".

5.7 Image Settings

5.7.1 Image Modes



- **IR:** Infrared images
- **Fusion:** An image combining infrared and visual images at a specific ratio. On the main interface, use the left/right buttons on the navigation pad to adjust the fusion ratio between infrared and visible light.
- **PIP:** Infrared image overlaid on the center of the visual image.
- **Visual:** Displays the visual image.
- **Imix:** The infrared image with enhanced object edge details.

Note: For better dual-spectrum image effects, you can manually align dual-spectrum images when using PIP, Fusion or Imix mode.

For alignment instructions, see Section 5.12.

5.7.2 Steps to Change Image Mode

1. In the thermal imaging interface, press the confirm button to display the main menu toolbar.
2. In the toolbar, select the "Image Mode" option and press the confirm button to display the sub menu toolbar.
3. In the toolbar, select the desired image mode and press the confirm button to switch to the selected mode.

5.7.3 Color Palette Settings

You can change the color palette used to differentiate between temperatures. Choosing an appropriate palette can make image analysis easier.

1. In the thermal imaging interface, press the confirm button to display the main menu toolbar.
2. In the toolbar, select the "Color Palette" option  and press the confirm button to display the sub menu toolbar.
3. In the toolbar, select a new color palette and press the confirm button to switch to the selected palette.

5.8 Shutter Calibration

5.8.1 Introduction to Shutter Calibration

Shutter calibration compensates for detector pixel non-uniformity or other optical interference. It is recommended when image quality deteriorates, commonly occurring in cases of rapid environmental temperature changes.

5.8.2 Shutter Calibration Operation

In the preview interface, press the back button to perform calibration. During shutter calibration, the screen will freeze momentarily, which is normal.

5.9 Digital Zoom

In the preview interface, use the left/right buttons on the navigation pad to adjust digital zoom in both infrared and visual image modes.

5.10 Fusion Ratio

In the preview interface, use the left/right buttons on the navigation pad to adjust the fusion ratio in fusion mode.

5.11 Temperature Difference Analysis

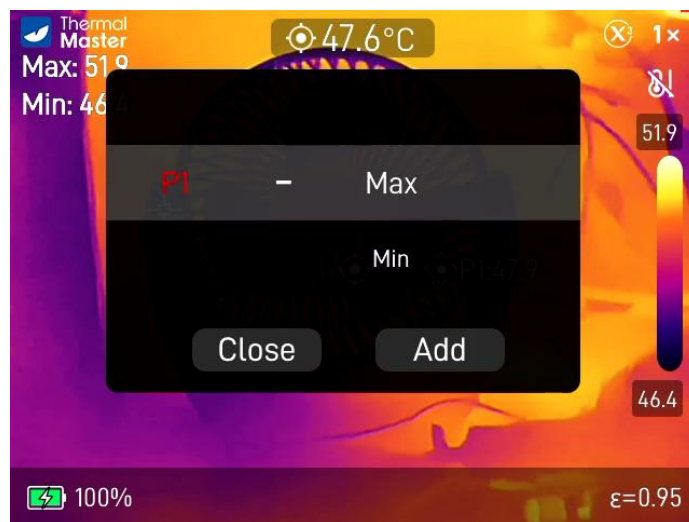

Perform temperature difference analysis by selecting any two of the predefined custom spots.

5.12 Dual-spectrum Alignment

1. In the thermal imaging interface, press the confirm button to display the main menu toolbar.
2. In the toolbar, select the "Image Mode"  option and press the confirm button to display the sub menu toolbar.
3. In the toolbar, select the "Alignment" option. Use the navigation buttons to adjust the position of the visual image in the imaging interface. Press the confirm button to confirm the adjustment or the back

button to exit the alignment interface.

6 Settings

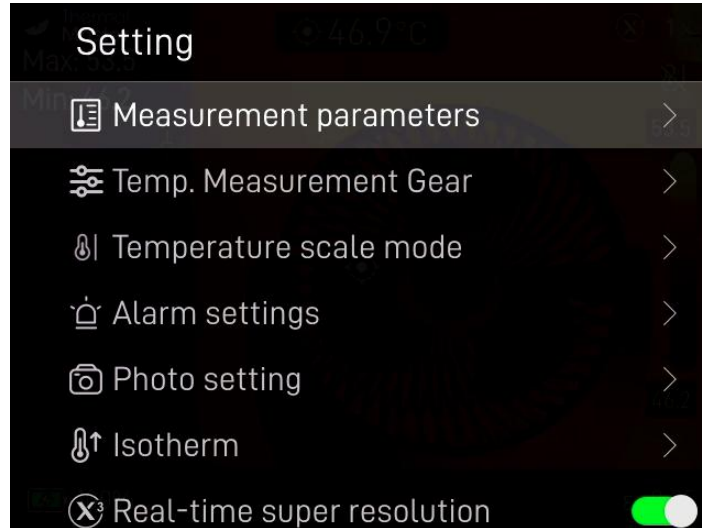

6.1 Measurement Parameters

6.1.1 Emissivity Settings

To obtain more accurate measurement results, you need to set the emissivity according to the target being measured before each measurement. Emissivity is the ratio of an object's radiation capability to that of a blackbody at the same temperature. It is inversely related to the object's reflectivity. With the same target temperature, a higher emissivity means the target radiates a higher proportion of energy outward.

For example:

Human skin emissivity: 0.98

Printed circuit board emissivity: 0.91

For additional emissivity values, refer to the quick start guide included in the packaging or consult other resources.

Emissivity Settings Procedure:

1. In the thermal imaging interface, press the confirm button to display the main menu toolbar.
2. In the toolbar, select the "Settings" option and press the confirm button to enter the settings menu.
3. From the list, select "Measurement Parameters", press the confirm button, and then choose "Emissivity" to configure.

6.1.2 Ambient Temperature Settings

1. In the thermal imaging interface, press the confirm button to display the main menu toolbar.
2. In the toolbar, select the "Settings" option  and press the confirm button to enter the settings menu.
3. From the list, select "Measurement Parameters", press the confirm button, and then choose "Ambient Temperature" to adjust the ambient temperature settings.

6.1.3 Distance Settings

Different distances can affect measurement results. To ensure accurate temperature measurement, the thermal camera requires distance information to compensate for the results.

1. In the thermal imaging interface, press the confirm button to display the main menu toolbar.
2. In the toolbar, select the "Settings" option  and press the confirm button to enter the settings menu.
3. From the list, select "Measurement Parameters", press the confirm button, and then choose "Distance" to adjust the distance settings.

6.2 Temperature Measurement Range

The camera offers three temperature measurement ranges: High-Temperature Range, Low-Temperature Range, and Auto Mode. Users should select the appropriate range based on operating conditions to ensure measurement accuracy.

6.3 Temperature Scale Mode

Click this menu or long-press the Gallery button to enter the Temperature Scale mode. Press the OK button to toggle between manual and auto temperature scale modes. In manual mode, short-press the Right button to enter threshold settings: full range, upper threshold, or lower threshold. Use the Up and Down buttons to adjust the thresholds; long-press for fast adjustment. After setting the thresholds, press the Left button to go back, then press the Back button to confirm and return to the preview interface.

6.4 Alarm Settings

The camera supports above and below temperature alarms. Users can configure the high-temperature threshold and low-temperature threshold and toggle the alarm function on or off through the settings. When triggered, a corresponding icon will appear on the screen.

If the "LED alarm" option is enabled, the camera will flash an LED light as an additional alert when the alarm is activated.

The alarm capture function allows users to set the interval and number of snapshots. Once this function is enabled and the alarm is triggered, the camera will capture images at the specified interval until the preset number of snapshots is reached. After this, the function will automatically disable, requiring manual reactivation for subsequent use.

6.5 Photo Settings

6.5.1 Auto Image Saving

When this function is enabled, images will be automatically saved after capturing.

6.5.2 Time-lapse Image Capture

The camera supports time-lapse image capture, allowing users to set the image capture interval and the number of images. When enabled, the device will take images at the specified interval and stop after reaching the preset number of images. This function will then automatically disable and requires manual reactivation for subsequent use.

6.6 Isotherm

Allows for isotherm settings.

6.7 Real-Time Super-Resolution

Enable or disable the real-time super-resolution feature.

6.8 Video Capture Settings

Options include automatic video saving and configuring silent video recording.

6.9 Index Mode

When this mode is enabled, the captured material will be numbered sequentially based on the order of capture.

6.10 Macro Lens (Note: This feature is not available on THOR002)

When a macro lens is added, this function needs to be enabled.

6.11 Unit Settings

The camera supports three temperature units: Celsius, Fahrenheit, and Kelvin. It also supports two distance units: meters and feet.

6.12 Wi-Fi Settings

When the camera's hotspot is enabled, it can connect to a client for wireless screen projection. The username and password will be displayed on the camera interface.

6.13 On-screen Display

Users can choose to enable or disable specific information according to personal preferences, such as the temperature scale, hot spots, memory card, time, emissivity, digital zoom, and battery. Alternatively, the "All" switch can be used to toggle all information on or off at once.

6.14 Auto Power Off

The camera supports auto shutdown settings with five options: 5 minutes, 10 minutes, 20 minutes, 120 minutes, and Off.

6.15 System Settings

In the system settings, users can view the device information and perform operations such as restoring factory settings, image calibration, formatting the SD card, adjusting screen brightness, setting the date and time, changing language settings, updating firmware, and viewing open-source licenses.

7 Technical Data

		THOR001	THOR002
Product Specifications	IR resolution	256x192	256x192
	Image frequency	25Hz	25Hz
	Pixel pitch	12μm	12μm
	Thermal sensitivity	< 35mk	< 40mk
	Lens focal length	4.3mm	4.3mm
	FOV	40°*30°	40°*30°
	I FOV (Spatial Resolution)	2.79mrad	2.79mrad
	Min focus distance	0.3m	0.3m
	Focus mode	Fixed focus	Fixed focus
	Digital camera, resolution	2MP	2MP
	Digital camera, focal length	2.01mm	2.01mm
	Digital camera, FOV	D:82.4°	D:82.4°
Temperature Measurement	Temperature measurement analysis	Center spot/Max/Min/6 Custom Spots/Temperature difference	Center spot/Max/Min/3 Custom Spots/Temperature difference
	Temperature measurement range	Low: -20~150℃ High: 100~550℃ Auto	Low: -20~150℃ High: 100~550℃ Auto
	Temperature measurement accuracy	±1.5% of the reading or ±1.5°	±2% of the reading or ±2°
	Unit	Temperature unit: Celsius, Fahrenheit, Kelvin Distance unit: meter, feet	Temperature unit: Celsius, Fahrenheit, Kelvin Distance unit: meter, feet
	Temperature resolution	0.1°	0.1°
	Ambient temperature	-10~50℃, in 1℃ increment	-10~50℃, in 1℃ increment
	Distance compensation	0.5-6m, in 0.5m increment	0.5-6m, in 0.5m increment

		THOR001	THOR002
	Emissivity	Adjustable from 0.01 to 1.0 Step size: 0.01	Adjustable from 0.01 to 1.0 Step size: 0.01
Image	Display	3.5"LCD (480x640)	3.5" LCD (480x640)
	Screen refresh rate	60Hz	60Hz
	Image mode	IR (default) , Fusion, PIP, Visual	IR (default) , Fusion, PIP, Visual
	Color Palettes	White hot, Black hot, Lava, Iron (default), Rainbow, Rainbow HC, Black red, High temperature highlight, Low temperature highlight	White hot, Black hot, Lava, Iron (default), Rainbow, Rainbow HC, Black red
	Isotherm	Support	Support
	Level/Span	Auto	Auto
	Digital Zoom	2x/4x/8x	2x/4x/8x
	Super-resolution	AI ISP 512*384	AI ISP 512*384
System	Language	English by default	English by default
	Image capture	Manual	Manual
	Time-lapse image capture	Support (with temperature data)	Support (with temperature data)
	Image saving	Auto, manual	Auto, manual
	QR code scanning	Support	Support
	File naming	Auto naming (Year-Month-Day-Hour-Minute-Second)	Auto naming (Year-Month-Day-Hour-Minute-Second)
	Video recording	Support (MP4, OSD info)	Support (MP4, OSD info)
	Temperature alarm	Max/Min temperature alarm	Max/Min temperature alarm
	Alarm method	Image pop-up, flashlight prompt	Image pop-up, flashlight prompt
	Auto image capture on alarm	Support	Support
	Image format	JPG	JPG
	Video transmission	Support	Support
	PC-based analysis software	Supports 13 languages (English by default)	Supports 13 languages (English by default)
Cloud	No	No	

		THOR001	THOR002
	APP	Support	Support
	Upgrade	Upgrade via SD card	Upgrade via SD card
	Auto shutdown	Configurable(Off, 5minutes,10 minutes, 20minutes, 120 minutes)	Configurable(Off, 5minutes,10 minutes, 20minutes, 120 minutes)
	Sleep/wake	Short press the power button to sleep/wake	Short press the power button to sleep/wake
	Power off duration	2S	2S
	Time to image	Long press for 1 second to power on Time to image is less than 6 seconds	Long press for 1 second to power on Time to image is less than 6 seconds
Peripheral	Storage	8GB RAM 32GB storage card	8GB RAM 32GB storage card
	Battery type	Built-in rechargeable lithium battery 21700 5000mAh	Built-in rechargeable lithium battery 21700 5000mAh
	Type-C 2.0	Charging, data transfer	Charging, data transfer
	LED lamp	Supports lighting and flashlight modes	Supports lighting and flashlight modes
	Charging indicator	Support	Support
	Power-off charging display	Support	Support
	Charging time	4 hours when powered off	4 hours when powered off
	Operating time	Over 6 hours	Over 6 hours
	Laser indicator	Available	Available
	Wireless	Available	Available
	Wrist strap	Available	Available
	Microphone	Available	Available
	Lens cap	Mechanical light shield/silicon plate	Mechanical light shield/silicon plate
	Tripod mount	Support	Support
	Additional lens	Macro	/
	Operating temperature	-20 to +55°C	-20 to +55°C
	Storage temperature	-20 to +60°C	-20 to +60°C
Relative humidity	10% to 95%, non-condensing	10% to 95%, non-condensing	

		THOR001	THOR002
	Protection level/drop resistance	IP54 2m	IP54 2m
	Package contents	USB cable, SD card, user documentation, certificate of conformity, calibration certificate, macro lens	USB cable, SD card, user documentation, certificate of conformity, calibration certificate

8 Application Scenario Introduction

8.1 Warehouse Inspection

With the help of a handheld thermal camera with a wide FOV, warehouse inspection personnel can quickly detect abnormal high-temperature items within the warehouse and take appropriate measures to eliminate safety hazards.

8.2 Switchgear Cabinet Inspection

The temperature distribution of power distribution equipment visually reflects its operational status. Poor contacts or damage may cause abnormal high temperatures. Using a handheld thermal camera, inspection personnel can promptly identify anomalies, ensuring the safety of the power distribution equipment.

8.3 Automobile Rear Window Defroster Maintenance

The heating wires on the rear window of a car are used for defrosting and de-fogging, particularly ensuring safety during rainy or snowy weather. The overall continuity of the heating wires cannot be visually detected through visible light. A handheld thermal camera allows quick detection of the entire heating wire system, helping analyze whether the wires are broken.

8.4 HVAC Maintenance

Handheld thermal cameras assist HVAC engineers in comprehensively capturing the temperature distribution of measured pipelines, quickly identifying abnormal points, making accurate judgments and pinpointing fault locations. This also helps avoid unnecessary demolition, reducing economic losses, improving service quality, and increasing customer satisfaction.

9 Dimensions

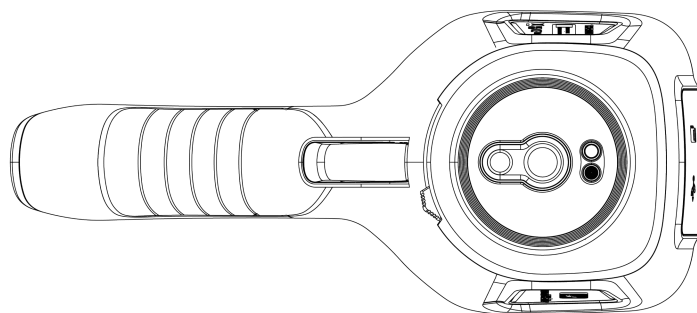
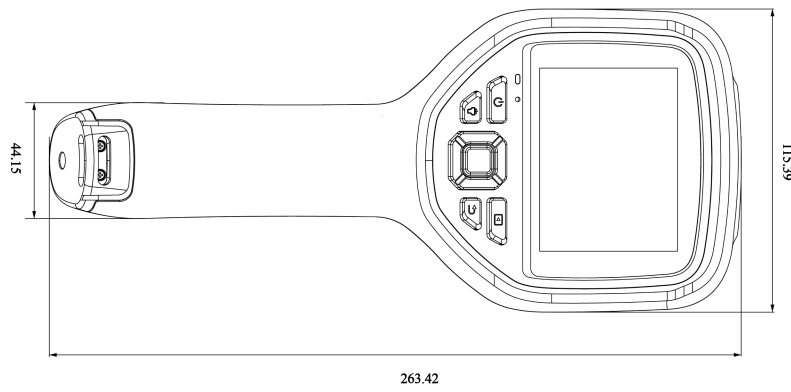
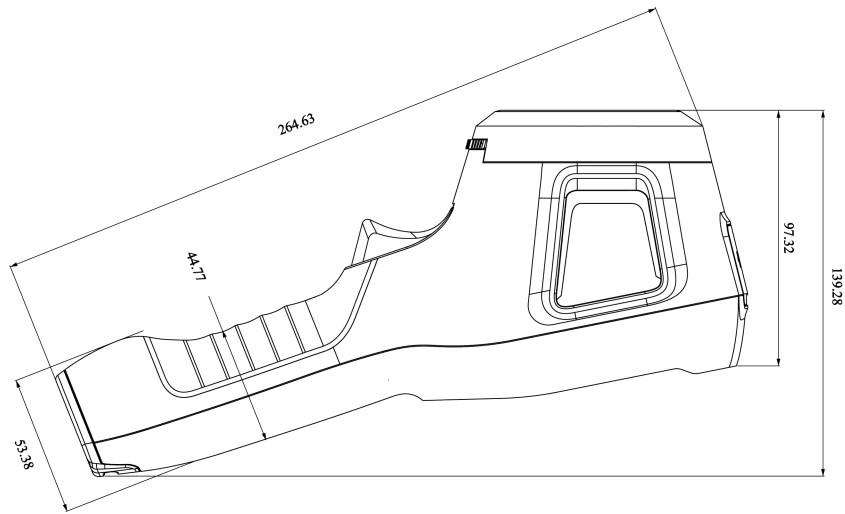

10.Cleaning Thermal Camera

10.1 Cleaning Camera Housing, Cables and Other Items

Camera Housing, Cables and Other Items	
Liquids	One of the following liquids can be used. 1.Warm water 2.A Weak detergent solution
Cleaning Tools	A soft cloth
Cleaning Procedure	Please follow this procedure: 1.Soak a soft cloth in the liquid. 2.Twist the cloth to remove excess liquid. 3.Clean the camera parts with the cloth.



CAUTION

Do not apply solvents or similar liquids to the camera, the cables, or other items. This can cause damage.

10.2 Cleaning Infrared Lens

Cleaning Infrared Lens	
Liquids	One of the following liquids can be used. 1. Commercial lens cleaning liquid with more than 30% isopropyl alcohol. 2. 96% ethyl alcohol(C ₂ H ₅ OH).
Cleaning Tools	cotton wool
Cleaning Procedure	Please follow this procedure: 1.Soak the cotton wool in the liquid. 2.Twist the cotton wool to remove the excess liquid. 3. Clean the lens one time only and discard the cotton wool.



CAUTION

Do not clean the infrared lens too vigorously. This can damage the anti-reflective coating.

Appendix A Emissivity of Commonly Used Materials

(1) Metal

Material	Temperature (°C)	Emissivity
Aluminum		
Polished aluminum	100	0.09
Commercial aluminum foil	100	0.09
Mild aluminum oxide	25 ~ 600	0.10 ~ 0.20
Strong aluminum oxide	25 ~ 600	0.30 ~ 0.40
Brass		
Brass mirror (highly polished)	28	0.03
Brass oxide	200 ~ 600	0.59 ~ 0.61
Chromium		
Polished chromium	40 ~ 1090	0.08 ~ 0.36
Copper		
Copper mirror	100	0.05
Strong copper oxide	25	0.078
Cuprous oxide	800 ~ 1100	0.66 ~ 0.54
Molten copper	1080 ~ 1280	0.16 ~ 0.13
Gold		
Gold mirror	230 ~ 630	0.02
Iron		
Polished cast iron	200	0.21
Machined cast iron	20	0.44
Completely rusted surface	20	0.69
Cast iron (oxidized at 600°C)	19 ~ 600	0.64 ~ 0.78
Electrolytic iron oxide	125 ~ 520	0.78 ~ 0.82
Iron oxide	500 ~ 1200	0.85 ~ 0.89
Iron plate	925 ~ 1120	0.87 ~ 0.95
Cast iron, heavy iron oxide	25	0.8
Melted surface	22	0.94
Melted cast iron	1300 ~ 1400	0.29

Material	Temperature (°C)	Emissivity
Pure molten iron	1515 ~ 1680	0.42 ~ 0.45
Steel		
Steel (oxidized at 600°C)		
Steel oxide	100	0.74
Melted mild steel	1600 ~ 1800	0.28
Molten steel	1500 ~ 1650	0.42 ~ 0.53
Lead		
Pure lead (non-oxidized)	125 ~ 225	0.06 ~ 0.08
Mildly oxidized	25 ~ 300	0.20 ~ 0.45
Magnesium		
Magnesium oxide	275 ~ 825	0.55 ~ 0.20
Mercury		
Mercury	0 ~ 100	0.09 ~ 0.12
Nickel		
Electroplating and polishing	25	0.05
Electroplating without polishing	20	0.01
Nickel wire	185 ~ 1010	0.09 ~ 0.19
Nickel plate (oxidized)	198 ~ 600	0.37 ~ 0.48
Nickel oxide	650 ~ 1255	0.59 ~ 0.86
Nickel alloy		
Nickel-chromium (heat resistant) alloy wire (bright)	50 ~ 1000	0.65 ~ 0.79
Nickel-chromium alloy	50 ~ 1040	0.64 ~ 0.76
Nickel-chromium (heat resistant)	50 ~ 500	0.95 ~ 0.98
Silver		
Polished silver	100	0.05
Stainless steel		
18/8 stainless steel	25	0.16
304 (8Cr, 18Ni)	215 ~ 490	0.44 ~ 0.36
310 (25Cr, 20Ni)	215 ~ 520	0.90 ~ 0.97
Tin		

Material	Temperature (°C)	Emissivity
Commercial tin plate	100	0.07
Zinc		
Oxidation at 400°C	400	0.01
Galvanized bright iron plate	28	0.23
Grey zinc oxide	25	0.28

(2) Non-metal

Material	Temperature (°C)	Emissivity
Brick	1100	0.75
Firebrick	1100	0.75
Graphite (lamp black)	96 ~ 225	0.95
Enamel (white)	18	0.9
Asphalt	0 ~ 200	0.85
Glass (surface)	23	0.94
Heat-resistant glass	200 ~ 540	0.85 ~ 0.95
Wall plaster	20	0.9
Oak	20	0.9
Carbon sheet	-	0.85
Insulating sheet	-	0.91 ~ 0.94
Metal sheet	-	0.88 ~ 0.90
Glass tube	-	0.9
Coil type	-	0.87
Enamel product	-	0.9
Enamel pattern	-	0.83 ~ 0.95
Capacitor		
Rotary type	-	0.30 ~ 0.34
Ceramic (bottle type)	-	0.9
Film	-	0.90 ~ 0.93
Mica	-	0.94 ~ 0.95
Flume type mica	-	0.90 ~ 0.93

Material	Temperature (°C)	Emissivity
Glass	-	0.91 ~ 0.92
Semiconductor		
Transistor (plastic package)	-	0.80 ~ 0.90
Transistor (metal)	-	0.30 ~ 0.40
Diode	-	0.89 ~ 0.90
Transmitting coil		
Pulse transmission	-	0.91 ~ 0.92
Flat chalk layer	-	0.88 ~ 0.93
Top ring	-	0.91 ~ 0.92
Electronic materials		
Epoxy glass plate	-	0.86
Epoxy phenol plate	-	0.8
Gold-plated copper sheet	-	0.3
Solder-coated copper	-	0.35
Tin-coated lead wire	-	0.28
Copper wire	-	0.87 ~ 0.88